

TeethXpress[®]

technique manual



TeethXpress®

immediate-load solutions



Case Courtesy of:
Andrew Ferrier, DDS, Prosthodontist, Lafayette, CA
Arshiya Sharafi, DDS, Oral Surgeon, San Diego, CA

Table of Contents:

Page

Soft tissue flap preparation and ridge reduction	2
Osteotomy preparation and implant placement	3-5
Multi-unit abutment placement and denture modification	5-6
Multi-unit abutment impression and titanium coping modification	7-8
TeethXpress prosthetic pick up, final modification & delivery	9-10
Prosthetic platforms	11
Multi-unit abutments & components	12-16
Prosthetic instrumentation	17-18
Support materials	19

Your patients need full-arch treatment. Give them TeethXpress®

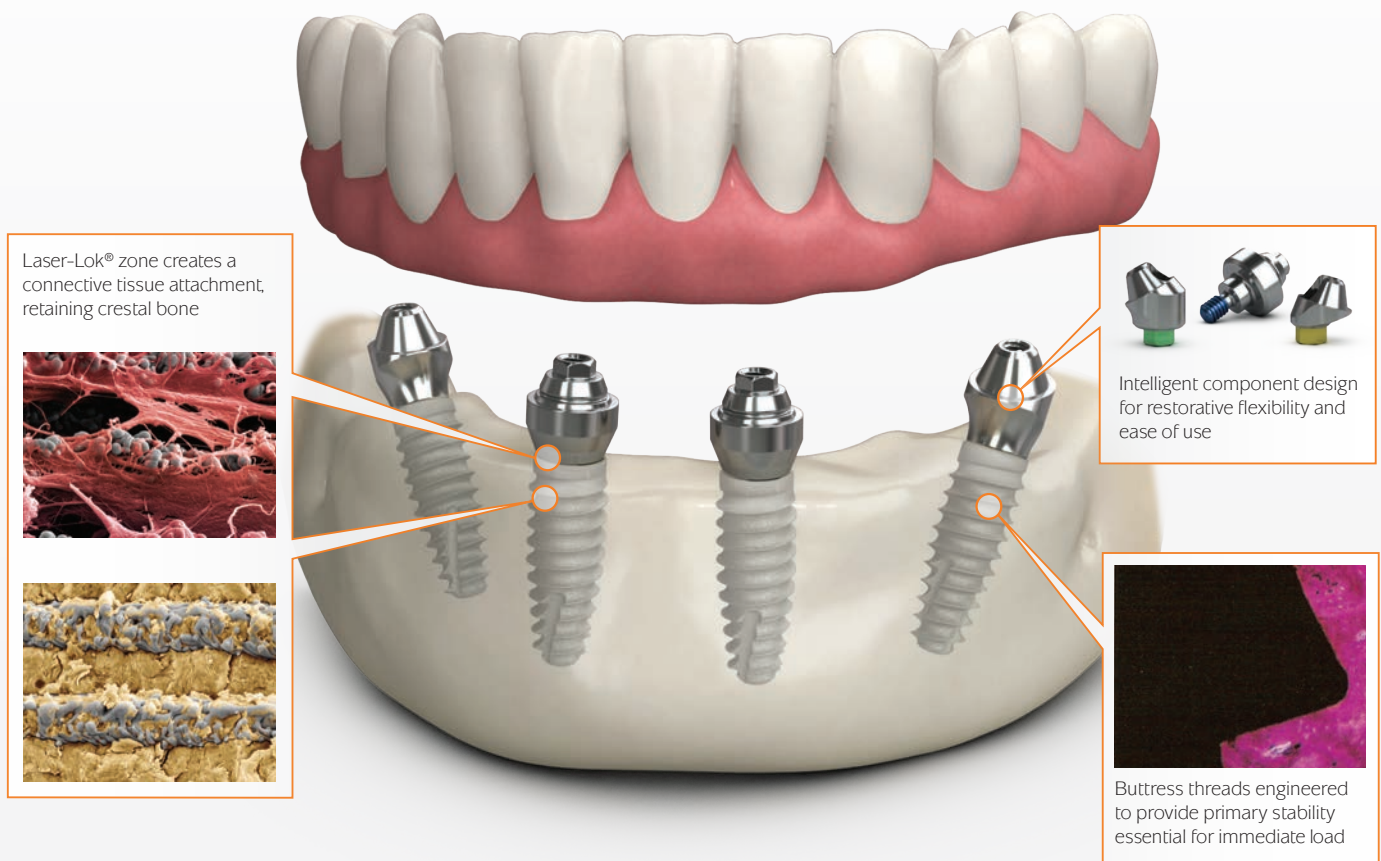

This surgical manual serves as a reference for using Tapered family implants and Multi-unit abutments in the TeethXpress protocol. It is intended solely to provide instructions on the use of BioHorizons products. It is not intended to describe the methods or procedures for diagnosis, treatment planning, or placement of implants, nor does it replace clinical training or a clinician's best judgment regarding the needs of each patient. BioHorizons strongly recommends appropriate training as a prerequisite for the placement of implants and associated treatment.

The procedures illustrated and described within this manual reflect idealized patient presentations with adequate bone and soft tissue to accommodate implant placement. No attempt has been made to cover the wide range of actual patient conditions that may adversely affect surgical and prosthetic outcomes. For more in-depth training, attend a full-arch, immediate-load course.

Clinician judgment as related to any specific case must always supersede any recommendations made in this or any BioHorizons literature.

Extract remaining teeth and create releasing incisions

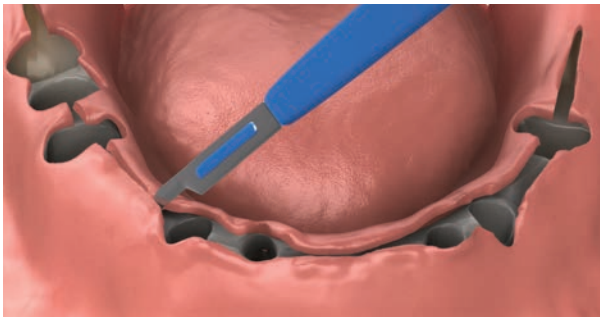

Extract remaining dentition.

Following extractions, release the soft tissue with crestral incisions using a #15 blade.

Create full thickness flap

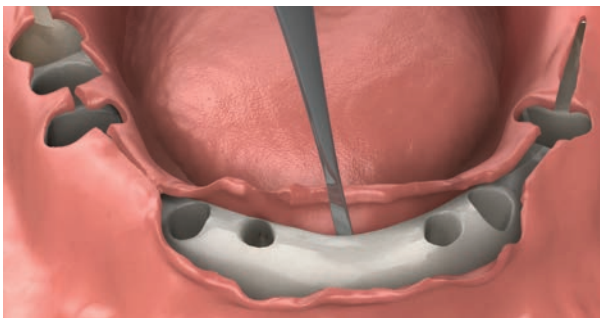

Fully expose the alveolar crest of the ridge using a periosteal elevator. Note the location of each mental foramen.

Reduce ridge

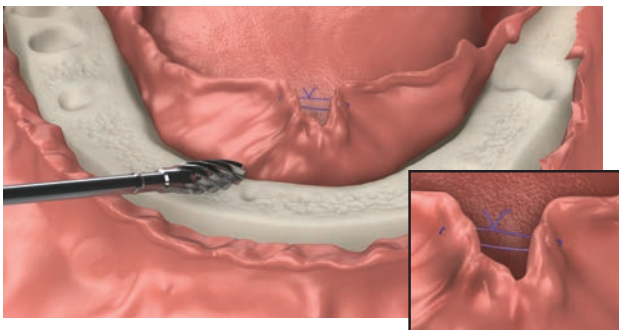

Reduce the height of the ridge using an aggressive alveolar cutting bur to create at least 15mm of inter-arch occlusal space. If the required 15mm occlusal space is present due to atrophy, an alveoplasty may not be required.

Note: The mandibular lingual flap can be temporarily sutured to keep the lingual tissue from obscuring the surgical area.

Draw a 30° guide mark

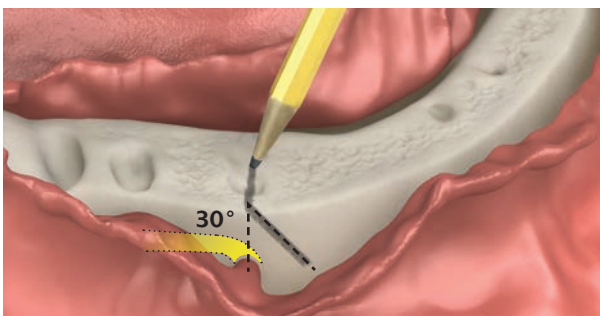

Use a sterile #2 pencil to draw a line from buccal to lingual, across the crest of the ridge above the mental foramen. Draw a 30° guide mark on the facial of the ridge, anterior to the mental foramen.

SURGICAL PROTOCOL

Establish angled posterior osteotomies

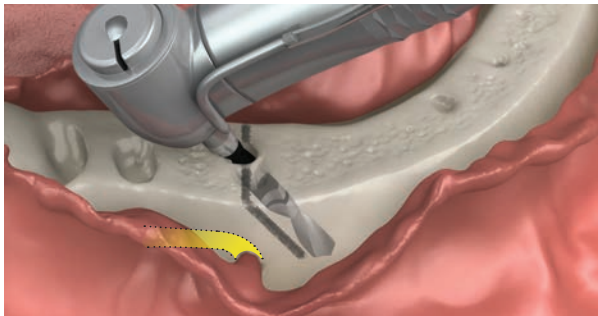

Initiate the two posterior osteotomies using a BioHorizons 1.5mm or 2.0mm diameter starter drill. In the center of the buccal-lingual drawn line, drill parallel with the 30° mark, anterior to the mental foramen, to achieve adequate A/P* spread and avoid damaging the mental nerve.

**Anterior/Posterior spread*

Verify adequate A/P spread and angulation



Confirm proper osteotomy position using the surgical guide and two 30° angled parallel pins. The pins should emerge through the guide trough. Adjust the trajectory of the osteotomy as needed before widening.

Complete posterior osteotomy preparation

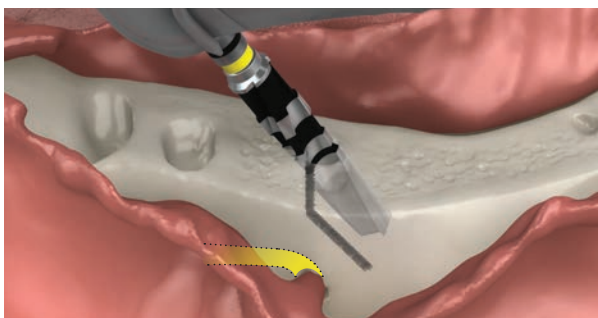

Widen the posterior osteotomy using the appropriate BioHorizons width increasing drills, maintaining the proper angle and A/P spread. Repeat steps on the opposing side.

Note: To achieve adequate torque values in soft bone, undersizing the osteotomy may be necessary.

Place posterior implants

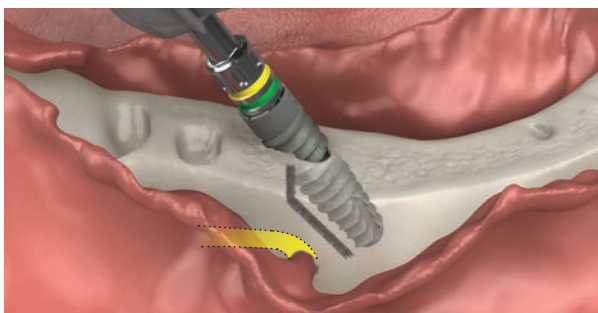

Remove the BioHorizons Tapered Internal implants from the sterile vials using a handpiece or ratchet implant-level driver. Deliver the implants to the prepared osteotomies. If the insertion torque is too high, adjust the osteotomies as necessary. If the insertion torque is too low, consider changing to a larger implant size.

Place Multi-unit try-in abutments

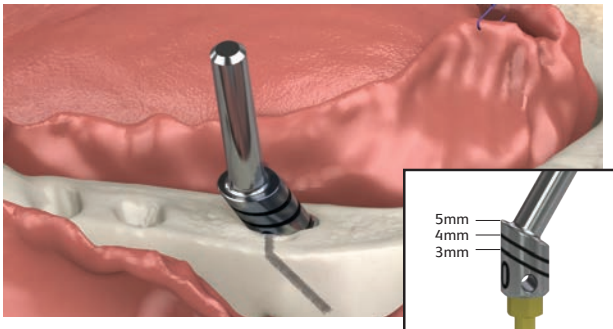

Use the BioHorizons 30° Multi-unit try-in abutment to verify proper implant hex orientation and to determine the necessary Multi-unit abutment height and angulation. Repeat steps on the opposing implant. Position the surgical guide to verify proper angulation and A/P spread.

Adjust internal hex orientation

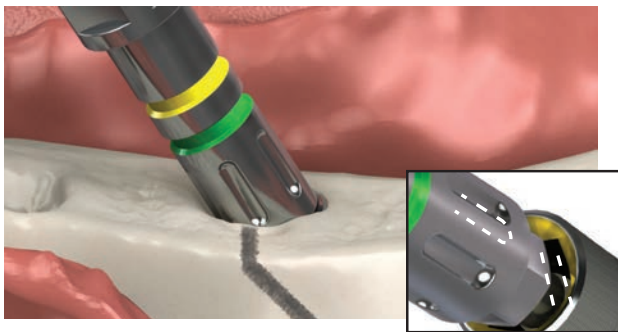

If the implant's internal hex orientation is incorrect, use the BioHorizons implant-level ratchet driver to adjust the internal hex orientation to its ideal positioning for the angled Multi-unit abutment.

Repeat the Multi-unit try-in abutment step to verify proper internal hex position.

Profile crestal bone around implant

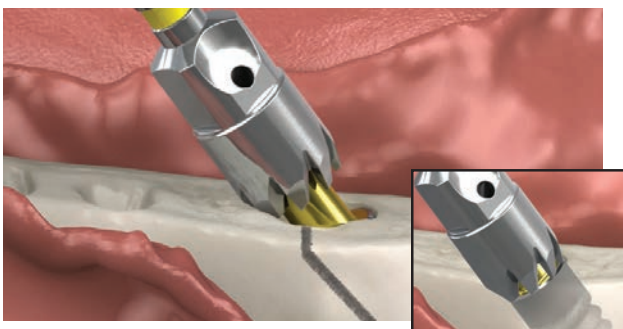

Following angled implant placement, screw in the BioHorizons profiler guide. Use a BioHorizons bone profiler to remove the crestal bone around the implant for a passive seating of the angled Multi-unit abutment.

Create anterior implant osteotomies

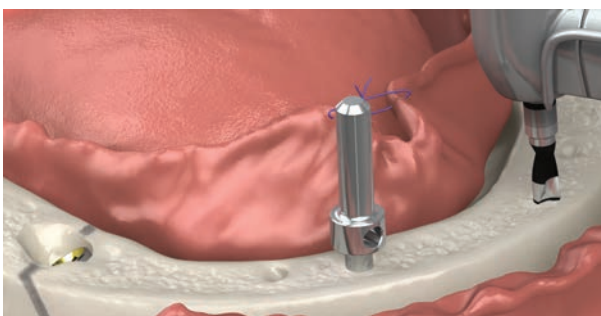

Initiate the anterior osteotomies using a BioHorizons Tapered Internal 2.0 diameter starter drill. Verify the correct implant trajectory using straight 2.0 parallel pins and the surgical guide.

Note: In some instances, a 17° degree angled Multi-unit abutment may be necessary to create the proper angle through the guide trough.

Complete anterior osteotomy preparation

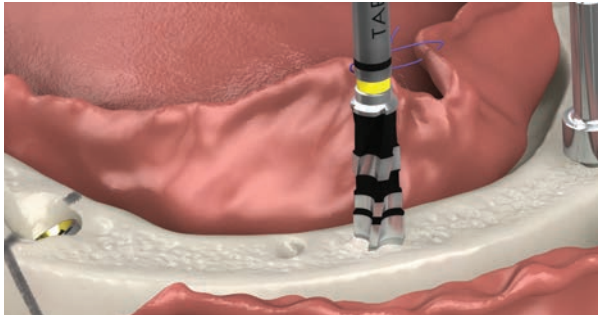

Widen the osteotomy using the appropriate BioHorizons width increasing drills, maintaining the proper angle and A/P spread.

Place anterior implants

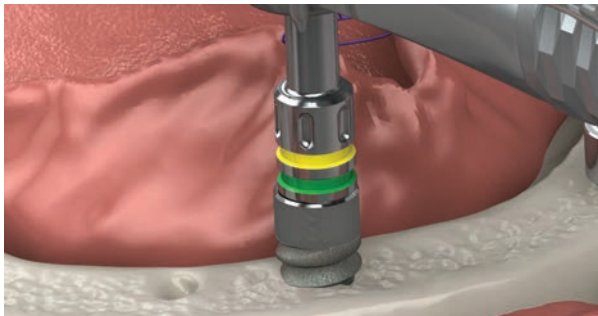

Place the anterior implants. Adjust the internal hex orientation to its ideal position if an angled Multi-unit abutment is required. Verify angulation using the angled Multi-unit try-in abutments and determine necessary abutment height.

Deliver anterior implant Multi-unit abutments

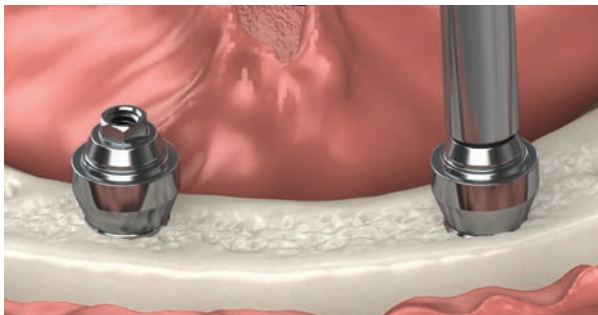

Remove the straight Multi-unit abutments from the packaging and place in the anterior implants using the attached plastic carrier. Hand-tighten the abutments using a manual Multi-unit hex adaptor.

Remove angled Multi-unit abutment from casing

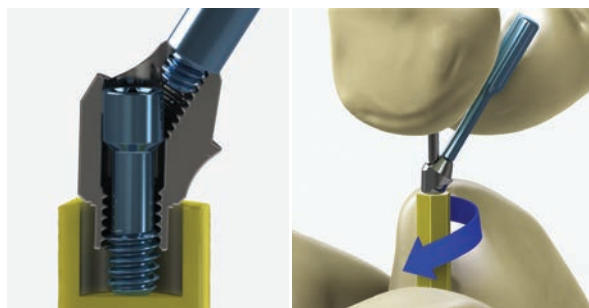

Attach a Multi-unit carrier (MUCA) and .050" hex driver to the angled Multi-unit abutment and hold in one hand. Use the other hand to unscrew the plastic carrier from the abutment.

Deliver posterior implant Multi-unit abutments

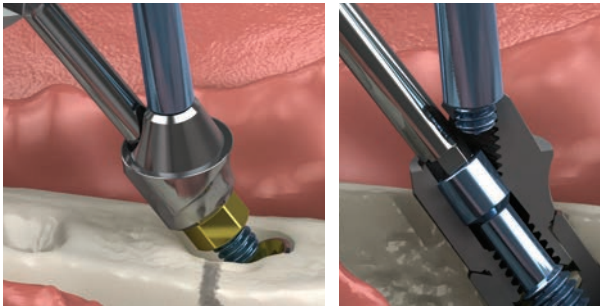

Seat the Multi-unit abutment hex in a posterior implant using the Multi-unit carrier and hand-tighten the abutment screw using the .050" hex driver. Remove the Multi-unit carrier and torque the abutment screw up to 30 Ncm*. Use an alveolar cutting bur to flatten divot areas around the angled implants and to smooth out sharp edges of the ridge. Use MinerOss cortical & cancellous bone chips to fill all voids created from the extractions.

** May be necessary to hand tighten the Multi-unit abutment screw if the implant torque value was less than 30 Ncm.*

Place Multi-unit cover caps and suture flap

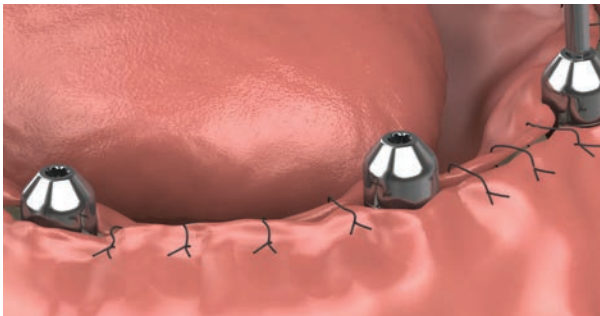

Hand-tighten the Multi-unit cover caps that came with the abutments using a .050" hex driver. Trim off any excess soft tissue and completely close the flap around the cover caps using an abundance of interrupted sutures from the midline to the posterior. Verify that bleeding is minimal as to not affect the subsequent impression steps. The surgical site is now ready for the TeethXpress immediate denture conversion.

Capture Multi-unit abutment positions



Cover the intaglio surface of the immediate denture using bite registration material. Place the denture over the ridge and press down to register the cover caps.

Create pilot holes in the denture

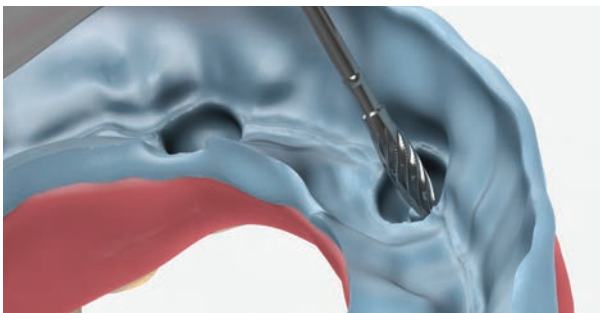

After the material sets, remove the denture and use a fissure bur to cut pilot holes in the indentations created in the bite registration material. Keep the bite registration material in place.

RESTORATIVE PROTOCOL

Verify modified denture

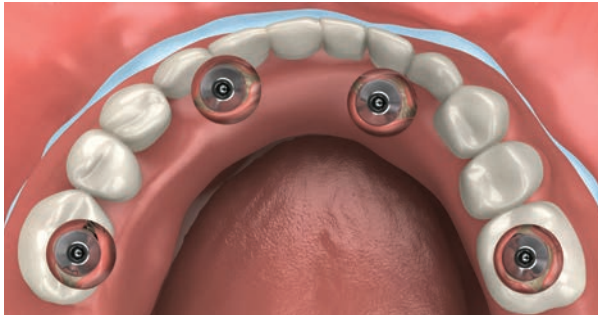

Using a pear-shape carbide bur, continue to widen each of the holes and check fit until there is 2-3mm of clearance completely around each cover cap. Do not be concerned about the denture teeth. There should be lateral play between the denture and the Multi-unit cover caps. Remove the bite registration material when this step is complete.

Take impression

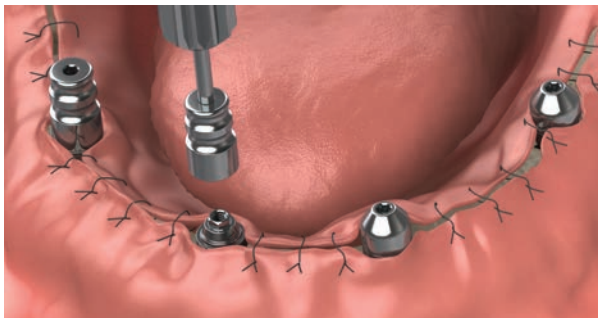

Replace the cover caps with direct or indirect Multi-unit impression copings using an .050" hex driver. Take an impression. Remove the Multi-unit impression copings.

Lab Step - Connect Multi-unit replicas



Attach Multi-unit abutment replicas to the impression copings and fabricate a working model in minimal expansion, high hardness die stone. A soft tissue material may be used to establish a soft tissue model.

Lab Step - Create working model

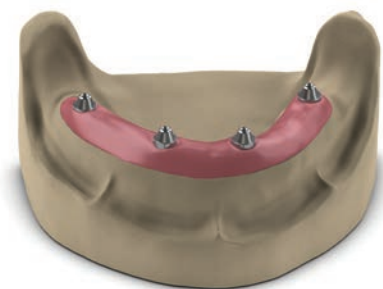

Verify proper replica seating and apply lubricant around the replicas where a soft tissue model will need to be created. Once set, prepare the working cast for the provisional prosthesis to be attached for additional modifications.

Seat and mark titanium copings

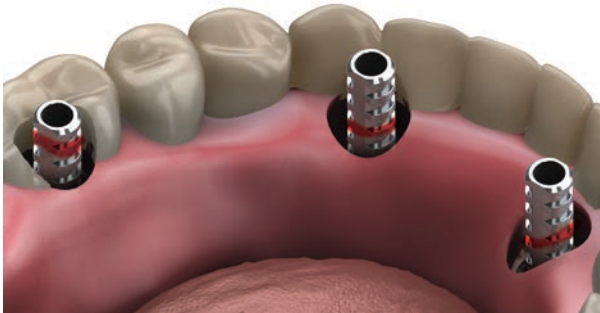

Place each Multi-unit titanium coping. Seat the denture in the mouth and verify 2-3mm clearance around each titanium coping. Further widen the holes as necessary. Use a marker to indicate where titanium copings need to be reduced to be 1 mm below the denture surface.*

**Adequate bone reduction reduces this need and makes the denture less prone to fracture.*

Reduce titanium copings



Remove each titanium coping from the mouth. Reduce the height of each titanium coping as necessary using a titanium cutting disc or bur. Titanium copings can be attached to a BioHorizons analog handle* for easier handling.

**Attach a straight Multi-unit abutment directly to the Analog Handle, then attach the titanium coping.*

Reseat the prepared titanium copings

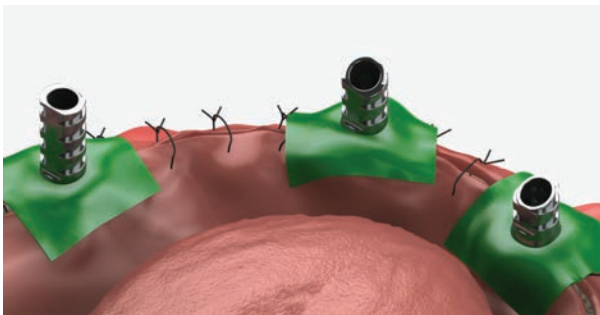

Reattach the titanium copings using a long .050" hex driver and hand-tighten. Place a square-shaped piece of rubber dam (with a small hole punched in the center) around each titanium coping to protect the wound and sutures from acrylic material.

Block screw access channels

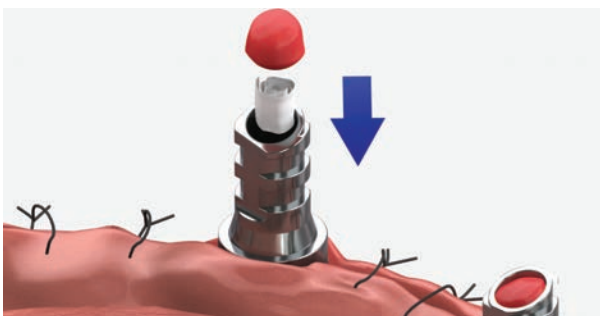

Place a rolled PTFE membrane material* in each titanium coping using a perio probe and cover with a small piece of wax to prevent acrylic from infiltrating the abutment screw.

**Often referenced clinically as "Teflon® tape".*

RESTORATIVE PROTOCOL

Pick up copings with denture

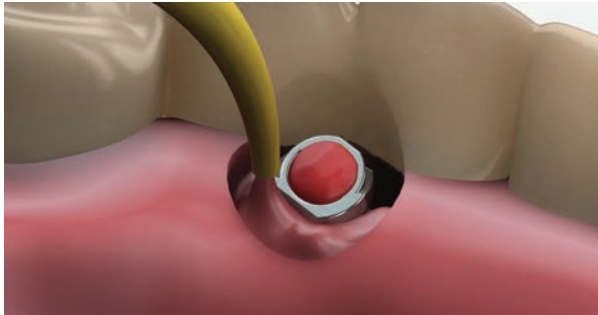

Seat the denture back in the patient's mouth. Use a small-tipped syringe to flow acrylic or pink composite material around each of the titanium copings to capture and pick them up in the denture. Immediately wipe away excess material from the occlusal surfaces and the top of the titanium copings. The patient is immediately guided into Centric Relation (CR) and held in the CR position until the acrylic material sets.

Remove prosthesis for final modifications



Once the acrylic material has set, the wax, Teflon tape and coping screws are removed. The denture is removed from the patient's mouth with the titanium copings picked up. The lab technician will fill any voids around the copings during the laboratory finishing.

An extra-long 0.50" hex driver (19mm) may be necessary depending on the depth of the titanium copings and the thickness of the TeethXpress prosthesis.

Lab Step - Modify denture

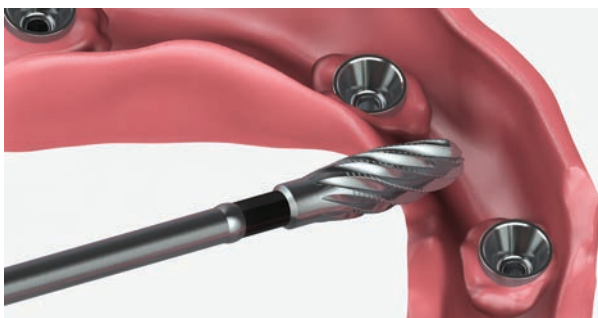

Modify the provisional prosthesis by removing the flanges and distal cantilevers using a carbide bur. For maxillary cases, remove the palate as well. Fill in any voids, and smooth all rough edges.

Lab Step - Attach denture to working model



Secure the provisional prosthesis to the working cast and make any final modifications. Once adjustments are complete, final polishing is performed in preparation for delivery to the patient.

RESTORATIVE PROTOCOL

Deliver provisional prosthesis

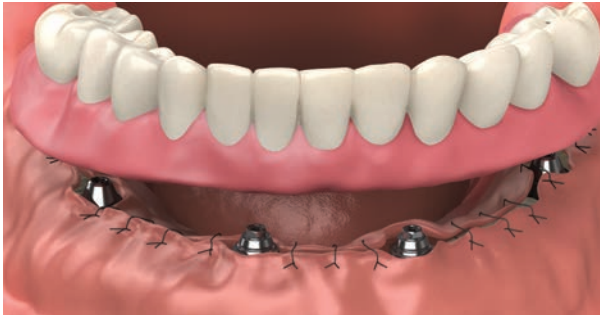

Seat the provisional prosthesis in the patient's mouth and hand-tighten the coping screws using a long or extra-long .050" hex driver. Check the patient's occlusion and make any necessary adjustments. Additional adjustments can be made as needed during subsequent visits.

Cover screw access channels



Place rolled Teflon tape in each titanium coping, cover with wax and light-cured acrylic material.

TeethXpress procedure is complete



The TeethXpress procedure is complete. Send the patient home with the TeethXpress Soft Diet Suggestions and any other necessary post-operative instructions.

IMPLANT & MULTI-UNIT ABUTMENT PLATFORM

Prosthetic platform color coding

BioHorizons prosthetic components are color-coded to match BioHorizons implant prosthetic platform. The 3.5mm (Yellow) is the most common platform used for the TeethXpress procedure.

There are multiple implant diameters that come with a 3.5mm platform*. Surgeons can use these options to match the appropriate diameter implant to the site conditions while minimizing the number of Multi-unit abutments in their inventory.

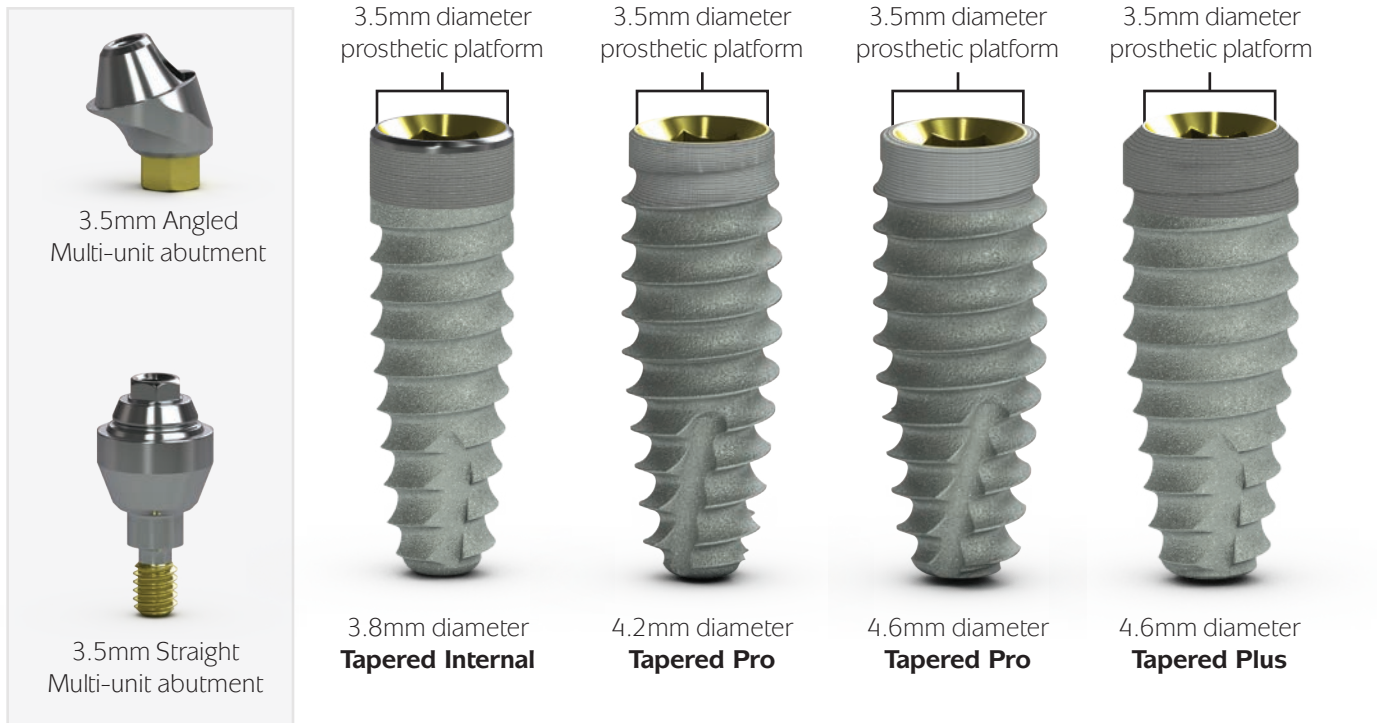

* Available BioHorizons Multi-unit abutment sizes include 3.0 (Gray), 3.5 (Yellow), 4.5 (Green) and 5.7mm (Blue) to correspond with the available implant platform sizes. The corresponding implant and Multi-unit abutment sizes should be present at the time of the TeethXpress surgery.

MULTI-UNIT ABUTMENTS

Straight Multi-unit Abutments

	1mm collar	2mm collar	3mm collar	4mm collar	5mm collar
3.0mm platform	TP3MU1	TP3MU2	TP3MU3	-	-
3.5mm platform	PYMU1	PYMU2	PYMU3	PYMU4	PYMU5
4.5mm platform	PGMU1	PGMU2	PGMU3	PGMU4	PGMU5
5.7mm platform	PBMU1	PBMU2	PBMU3	-	-

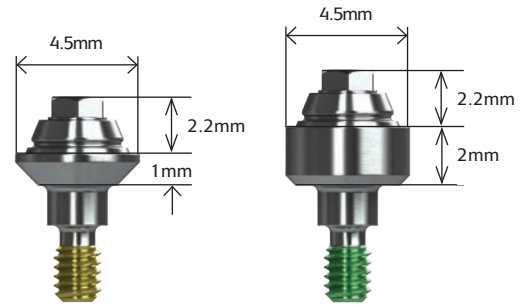

Straight Multi-unit abutments may be used for multiple-unit restorations including: screw-retained restorations at the abutment level, cast alloy bars for overdentures and fixed/detachable (hybrid) restorations. Comes with a cover cap (PXMUCC). Final torque: 30 Ncm using a Multi-unit Hex Adapter. Titanium alloy.

17° Angled Multi-unit Abutments

	2.25mm collar	3mm collar	4mm collar
3.0mm platform	TP3MU172	TP3MU173	-
3.5mm platform	PYMU172	PYMU173	PYMU174
4.5mm platform	PGMU172	PGMU173	PGMU174
5.7mm platform	PBMU172	PBMU173	-

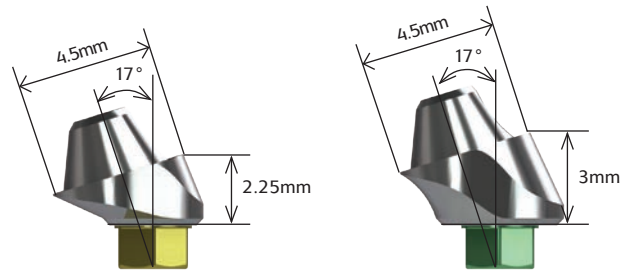

17° Angled Multi-unit abutments may be used to angle-correct divergent implants. Use for multiple-unit restorations including: screw-retained restorations at the abutment level, cast alloy bars for overdentures and fixed/detachable (hybrid) restorations. Comes with a cover cap (PXMUCC) and abutment screw (PXMUAS). Final torque: 30 Ncm. Titanium alloy. Conveniently deliver abutment one-handed using an .050 hex or Unigrip™ driver or two-handed using an angled Multi-unit carrier (MUCA).

30° Angled Multi-unit Abutments

	3mm collar	4mm collar	5mm collar
3.0mm platform	TP3MU303	TP3MU304	-
3.5mm platform	PYMU303	PYMU304	PYMU305
4.5mm platform	PGMU303	PGMU304	PGMU305
5.7mm platform	PBMU303	PBMU304	-

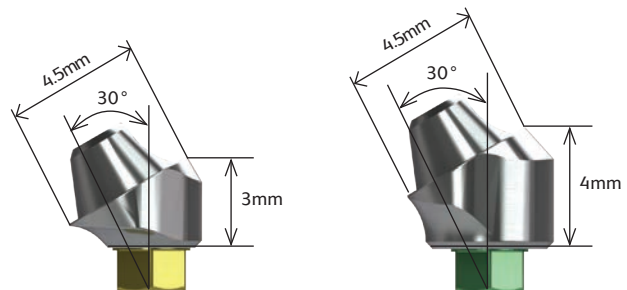

30° Angled Multi-unit abutments may be used to angle-correct divergent implants. Use for multiple-unit restorations including: screw-retained restorations at the abutment level, cast alloy bars for overdentures and fixed/detachable (hybrid) restorations. Comes with a cover cap (PXMUCC) and abutment screw (PXMUAS). Final torque: 30 Ncm. Titanium alloy. Conveniently deliver abutment one-handed using an .050 hex or Unigrip™ driver or two-handed using an angled Multi-unit carrier (MUCA).



- L02015-028 Multi-unit abutment hybrid or fixed-detachable-screw-retained restoration module
- L02015-029 Multi-unit abutment bar overdenture - screw-retained restoration module
- L02015-031 Correcting a non-passive framework module

MULTI-UNIT COMPONENTS

Laser-Lok Straight Multi-unit Abutments

	2mm collar	3mm collar
3.0mm platform	TP3MU2L	TP3MU3L
3.5mm platform	PYMU2L	PYMU3L
4.5mm platform	PGMU2L	PGMU3L

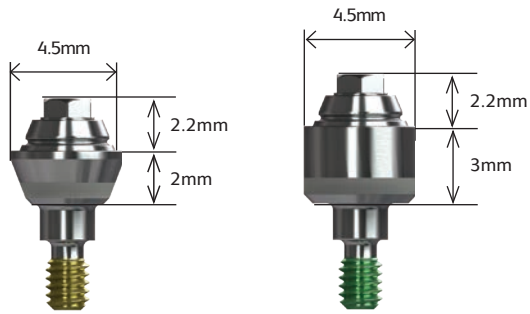

Laser-Lok Straight Multi-unit abutments may be used for multiple-unit restorations including: screw-retained restorations at the abutment level, cast alloy bars for overdentures and fixed/detachable (hybrid) restorations. When a Laser-Lok component is used and temporarily removed, keep the removed Laser-Lok component in sterile saline until reinserting into the site. Comes with a cover cap (PXMUCC). Final torque: 30 Ncm using a Multi-unit Hex Adapter. Titanium alloy.

 **L02015-003** Handling of Laser-Lok abutments module

Multi-unit Copings

PXMUTC

Titanium

Use for fabricating acrylic temporary and final prostheses. May be trimmed for height. Packaged with prosthetic screw (PXMUPSR). Titanium alloy.

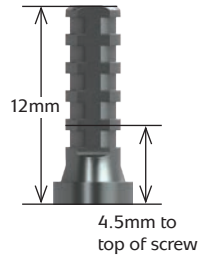

PXMUGC

Gold Custom Castable

Use for fabricating metal-reinforced acrylic prostheses or bar overdentures. May be trimmed for height. Packaged with prosthetic screw (PXMUPSR). Coping has a gold alloy base with acetal resin (Delrin® or Pomalux®) sleeve.

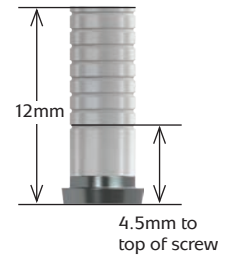

PXMUPC

Plastic Custom Castable

Use for fabricating metal-reinforced acrylic prostheses or bar overdentures. May be trimmed for height. Packaged with prosthetic screw (PXMUPSR). Acetal resin (Delrin® or Pomalux®)

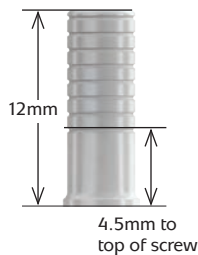

PXMUPFC

Passive Fit

Use for fabricating metal-reinforced acrylic prostheses or bar overdentures, cemented using the passive-fit technique. May be trimmed for height. Packaged with regular and long prosthetic screws (PXMUPSR, PXMUPSL). Coping has a titanium alloy base with acetal resin (Delrin® or Pomalux®) sleeve.



MULTI-UNIT COMPONENTS

Multi-unit Locators®

- LMUTC-2** Locator Multi-unit Abutment w/ Ti Collar (2 pack)
- LMUTC-10** Locator Multi-unit Abutment w/ Ti Collar (10 pack)

Use Male Processing Package for these collars (LMPP-2 or LMPP-10).

- LMUDC-2** Locator Multi-unit Abutment w/ Delrin® Collar (2 pack)
- LMUDC-10** Locator Multi-unit Abutment w/ Delrin® Collar (10 pack)

Use Locator Multi-unit Bar Processing Package listed below for these collars.

- LMUBPP-2** Locator Multi-unit Bar Processing Package (2 pack)
- LMUBPP-10** Locator Multi-unit Bar Processing Package (10 pack)

Locator attachments for Multi-unit abutments have been designed as a free-standing option (LMUTC) for the angled Multi-unit posterior sites and for castable bar-splinted applications (LMUDC). The Locator Multi-unit Bar Processing Package includes Denture Cap with Yellow Bar Processing Male, Dual Retentive Replacement Males: Clear, Pink, Blue, and Block-Out Spacer. Offered in 2 packs and 10 packs. For complete instructions, visit the Zest Anchors website.

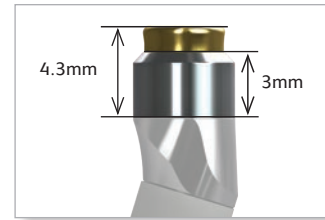
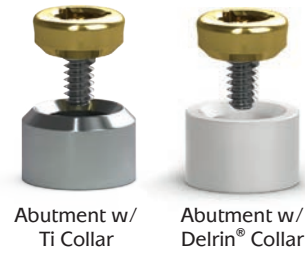

Multi-unit Impression Copings

- PXMUDPC** Direct Pick-up Coping, Multi-unit

Use to make a direct pick-up impression (open-tray) at the abutment level. Packaged with a prosthetic screw, long. Titanium alloy. Hand tighten.

- PXMUIC** Indirect Transfer Coping, Multi-unit

Use to make an indirect transfer (closed-tray) impression at the abutment level. Titanium alloy. Hand tighten.

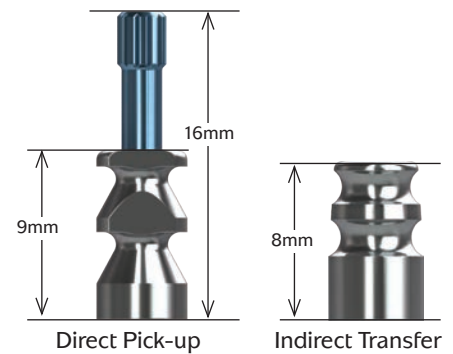

-  **L02015-010** Multi-unit abutment impression technique - direct open tray module
- L02015-011** Multi-unit abutment impression technique - closed tray module
- L02015-030** Verification jig fabrication module

MULTI-UNIT COMPONENTS

Multi-unit Coping Screws

- PXMUPSR** Prosthetic Screw, Multi-unit, Regular (pack of 5)
- PXMUPSR25** Prosthetic Screw, Multi-unit, Regular (pack of 25)
- PXMUPSL** Prosthetic Screw, Multi-unit, Long (pack of 5)
- PXMUPSS** Prosthetic Screw, Multi-unit, Short (pack of 5)

For attaching copings to the Multi-unit abutments. Hand-tighten or torque to 15 Ncm with .050" (1.25mm) Hex Driver or Unigrip™ screw driver, depending on application. Titanium alloy. Included with copings where indicated but can also be ordered separately.

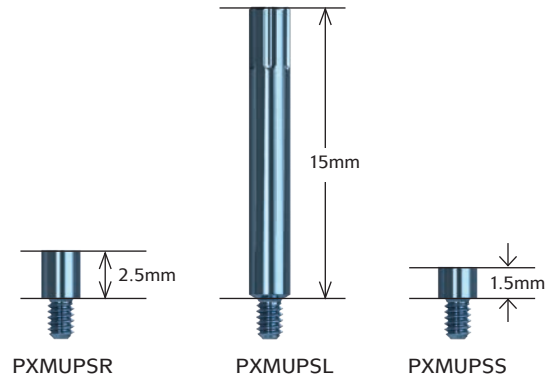

Multi-unit Angled Abutment Screw & Abutment Carrier

- PXMUAS** Abutment Screw, Multi-unit
- PXMUAS25** Abutment Screw, Multi-unit (pack of 25)

For angled Multi-unit abutments only. Final torque: 30 Ncm with .050" (1.25mm) Hex Driver or Unigrip™ screw driver. Titanium alloy. Included with abutment but can also be ordered separately.

- MUCA** Angled Multi-unit Abutment Carrier (pack of 3)

Use to deliver angled Multi-unit abutments to the surgical site. Titanium alloy.

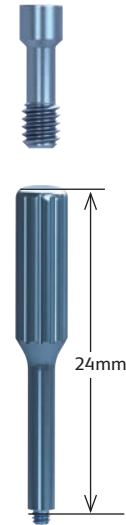

Multi-unit Cover Cap

- PXMUCC** Cover Cap, Multi-unit

Packaged with all Multi-unit abutments. Hand-tighten with .050" (1.25mm) Hex Driver or Unigrip™ screw driver. Titanium alloy.



Multi-unit Abutment Replica & Protection Analog

- PXMUAR** Abutment Replica, Multi-unit

Use at lab to represent the Multi-unit/Implant assembly in the working cast. Not for use with implant-level impressions. Titanium alloy.



- PXMUPA** Protection Analog, Multi-unit (pack of 5)

Use to protect abutment-coping interface when polishing the metal framework. Titanium alloy.



MULTI-UNIT COMPONENTS

Multi-unit Try-in Abutments

TRYTP3MU	3.0mm Multi-unit Try-in Straight Abutment
TRYPYMU	3.5mm Multi-unit Try-in Straight Abutment
TRYPGMU	4.5mm Multi-unit Try-in Straight Abutment
TRYPBMU	5.7mm Multi-unit Try-in Straight Abutment

Multi-unit Try-in Abutments may be used to measure tissue thickness and verify proper prosthetic seating prior to final abutment seating.

Each Try-in is laser marked from 1mm to 5mm to correspond with the Straight Multi-unit Abutment collar heights and can also be used as a measuring tool for OD Secure, Locator, Locator R-Tx and Ball abutment systems. Try-in is carried to the site by the handle and snaps into the implant.

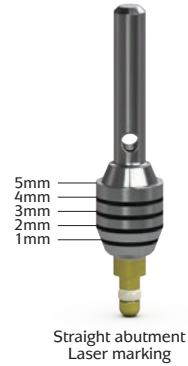

TRYTP3MU17	3.0mm Multi-unit Try-in 17° Angled Abutment
TRYPYMU17	3.5mm Multi-unit Try-in 17° Angled Abutment
TRYPGMU17	4.5mm Multi-unit Try-in 17° Angled Abutment
TRYPBMU17	5.7mm Multi-unit Try-In 17° Angled Abutment

TRYTP3MU30	3.0mm Multi-unit Try-in 30° Angled Abutment
TRYPYMU30	3.5mm Multi-unit Try-in 30° Angled Abutment
TRYPGMU30	4.5mm Multi-unit Try-in 30° Angled Abutment
TRYPBMU30	5.7mm Multi-unit Try-In 30° Angled Abutment

Each Try-in is laser marked to correspond with the Angled Multi-unit Abutment collar heights. Try-in is carried to the site by the handle and snaps into the implant.

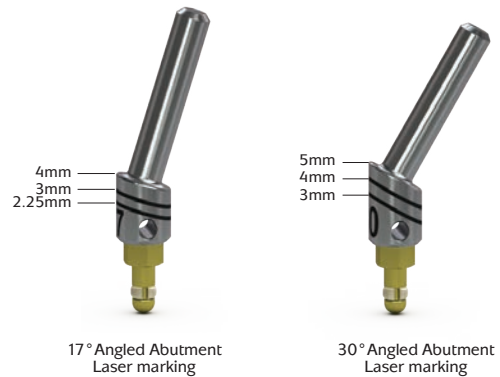

Multi-unit Hex Adapters for Straight Abutments

PXMUHAM Manual Multi-unit Hex Adapter

Use to hand tighten straight Multi-unit abutments.

PXMUHAH Handpiece Multi-unit Hex Adapter

Use to torque straight Multi-unit abutments. Driven by latch-type handpiece. Do not exceed 30 Ncm.

PXMUHAR 4mm Square Multi-unit Hex Adapter

Use to torque straight Multi-unit abutments. Driven by 4mm square drive handwrench, ratchet, or torque wrench. Do not exceed 30 Ncm.



Paralleling Pins

144-100	Straight Parallel Pins
144-200	20° Angled Parallel Pin
144-230	30° Angled Parallel Pin

Use parallel pins to assess implant angulation and estimate which angled abutment is appropriate for the restoration.



PROSTHETIC INSTRUMENTATION

Prosthetic Kit

- PROS3000** **Enhanced Prosthetic Instrumentation Kit**
Includes:
- .050 (1.25mm) Manual Hex Driver
 - .050 (1.25mm) Manual Hex Driver, Long
 - .050 (1.25mm) Handpiece Hex Driver
 - .050 (1.25mm) Handpiece Hex Driver, Long
 - .050 (1.25mm) 4mm Square Hex Driver
 - .050 (1.25mm) 4mm Square Hex Driver, Long
 - Hand Wrench
 - 4mm Square Drive Extender
 - 4mm Square Multi-unit Hex Adapter
 - 12 Try-in Abutment Slots
 - 8 Optional Instrument Slots
 - Space for Torque Wrenches & AS123 Hand Unit
- Multi-unit Try-in Abutments, 300-100 and ATW are sold separately.*



- PROS2500** **Prosthetic Instrumentation Tray (not shown)**
Tray without instruments (included with PROS3000)

- 300-100*** **AS123 Hand Unit**
Provides improved vision and easy access to prosthetic components in posterior regions of the mouth. Hand Wrench and Drivers are sold separately.



- 300-400*** **Hand Wrench**
Use on drive end of AS123 Hand Unit. Also fits individual Hex Drivers/Adapters and Bone Taps.

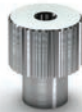

- 300-206*** **4mm Square Drive Extender**
Replaced 300-205 starting in June 2010. Includes PEEK C-ring for durable retention in Ratchet. Cannot be used with bone taps.



Torque Wrenches

- BIOTORO** **BioHorizons Adjustable Torque Wrench**
Adjustable torque wrench designed to attach to all 4mm drivers from BioHorizons. Supplied with a dual direction mechanism that allows for insertion and removal functions. When the desired torque is reached (a choice of 10Ncm to 30Ncm) the torque wrench snaps to avoid over torquing.



- ATW** **ITL Precise Adjustable Torque Wrench**
Place both implants and abutments with 9 distinct torque settings (15, 20, 25, 30, 35, 40, 45, 50 and 60 Ncm). A simple twist of the handle locks in precision-engineered torque values and guarantees accuracy and repeatability.



- EL-C12374** **Elos Adjustable Torque Wrench**
Lightweight titanium design is easy to use as an adjustable torque wrench or a ratchet. Quickly disassembles for cleaning. No calibration required.



- EL-C8521** **Elos Replacement Bit, 4mm Square Adapter**

- EL-C8381** **Elos Replacement Bit, Handpiece**

- AGYR-15500** **Torque Control 15500**
Ergonomic design is the ideal solution for access to screws placed in the posterior. The 7 predetermined torque values (10, 15, 20, 25, 30, 32 and 35 Ncm) make it a tool of extreme precision.



* Instrument o-rings & c-rings wear out over time. If an instrument is no longer held securely by its associated driver, order a replacement ring through Customer Care.

PROSTHETIC INSTRUMENTATION

.050" (1.25mm) Hex Drivers

- 135-251 Manual Hex Driver, Short
- 135-351 Manual Hex Driver
- 135-451 Manual Hex Driver, Long
- 134-350 Handpiece Hex Driver
- 134-450 Handpiece Hex Driver, Long
- 300-350* 4mm Square Hex Driver
- 300-351* 4mm Square Hex Driver, Long
- 300-354* 4mm Square Hex Driver, Extra Long

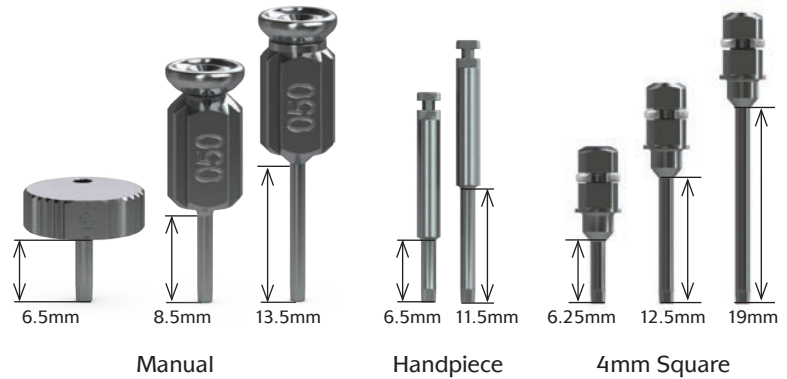

Abutment Prepping Handles

- TP3AH 3.0mm platform Analog Handle
- PYGAH 3.5/4.5mm platform Analog Handle
- PBAH 5.7mm platform Analog Handle



Use to comfortably hold abutments for chairside or laboratory preparation. Abutments are secured to the handle with a standard abutment screw (PXAS). Comes in three sizes: 3.0, 3.5/4.5 and 5.7mm.

Cheek Retractors

- 9061381 Comfortview Lip and Cheek Retractor, Universal
- 9061383 Comfortview Lip and Cheek Retractor, Small
- 9061382 Comfortview Refill Cushions, Pink (10/pack)

Achieve optimal buccal and gingival access. Anatomic design maximizes visibility and cushioned lip-supports provide greater patient comfort. Ideal for implant or full-arch procedures. Also suitable for use in diagnostic and preventive dental applications, digital impression scanning and intra-oral photography.

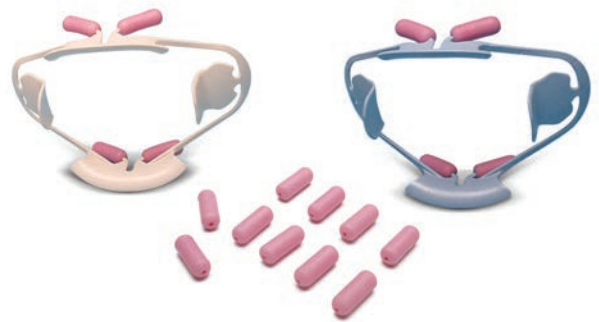

- TBD Retractor Vestibulum - Cheek Retractor

Use for effect cheek retraction in maxillary and mandibular full-arch implant procedures.



* For installation and removal of cover caps, prosthetic and abutment screws.

SUPPORT MATERIAL

TeethXpress Support Materials

- EP-TXMOD TeethXpress Patient Education Model
- ML0310 TeethXpress Patient Education Brochure
- ML0315 *TeethXpress* Patient Education Magazine
- ML0329 Solutions to Replace Missing Teeth - Patient Education Chart (pack of 25)





Custom Full-Arch Titanium Bars for BioHorizons Implant Systems

Vulcan Custom Dental is an advanced custom bar milling center offering the following benefits:

- Authentic connection for precision fit
- Titanium alloy (Ti6Al4V) milled framework for superior strength
- Quick turn-around times
- FDA clearance







WWW.VULCANDENTAL.COM • 844.484.2301

ORDERING & WARRANTY INFORMATION

Territory Manager: _____

cell phone: _____

email and/or fax: _____

BioHorizons Lifetime Warranty on Implants and Prosthetics: All BioHorizons implants and prosthetic components include a Lifetime Warranty. BioHorizons implant or prosthetic components will be replaced if removal of that product is due to failure (excluding normal wear to overdenture attachments).

Additional Warranties: BioHorizons warranties surgical drills, taps and other surgical and restorative instruments.

(1) Surgical Drills and Taps: Surgical drills and taps include a warranty period of ninety (90) days from the date of initial invoice. Surgical instruments should be replaced when they become worn, dull, corroded or in any way compromised. Surgical drills should be replaced after 12 to 20 osteotomies.¹

(2) Instruments: The BioHorizons manufactured instrument warranty extends for a period of one (1) year from the date of initial invoice. Instruments include drivers, implant site dilators and BioHorizons tools used in the placement or restoration of BioHorizons implants.

Return Policy: Product returns require a Return Authorization Form, which may be acquired by contacting Customer Care. The completed Return Authorization Form must be included with the returned product. For more information, please see the reverse side of the invoice that was shipped with the product.

Disclaimer of Liability: BioHorizons products may only be used in conjunction with the associated original components and instruments according to the Instructions for Use (IFU). Use of any non-BioHorizons products in conjunction with BioHorizons products will void any warranty or any other obligation, expressed or implied.

Treatment planning and clinical application of BioHorizons products are the responsibility of each individual clinician. BioHorizons strongly recommends completion of postgraduate dental implant education and adherence to the IFU that accompany each product. BioHorizons is not responsible for incidental or consequential damages or liability relating to use of our products alone or in combination with other products other than replacement or repair under our warranties.

Distributed Products: For information on the manufacturer's warranty of distributed products, please refer to their product packaging. Distributed products are subject to price change without notice.

Validity: Upon its release, this literature supersedes all previously published versions.

Availability: Not all products shown or described in this literature are available in all countries. BioHorizons continually strives to improve its products and therefore reserves the right to improve, modify, change specifications or discontinue products at any time.

Any images depicted in this literature are not to scale, nor are all products depicted. Product descriptions have been modified for presentation purposes. For complete product descriptions and additional information, visit store.biohorizons.com.

1) Heat production by 3 implant drill systems after repeated drilling and sterilization.
Chacon GE, Bower DL, Larsen PE, McGlumphy EA, Beck FM. *J Oral Maxillofac Surg.*

Direct Offices

BioHorizons USA
888-246-8338 or
205-967-7880

BioHorizons Canada
866-468-8338

BioHorizons Spain
+34 91 713 10 84

BioHorizons UK
+44 (0)1344 752560

BioHorizons Chile
+56 (2) 23619519

BioHorizons Italy
800-063-040

BioHorizons Mexico
800-953-0498

Distributors

For contact information in our 90 countries, visit biohorizons.com



BioHorizons®, Laser-Lok®, MinerOss®, AutoTac®, Mem-Lok® and TeethXpress® are registered trademarks of BioHorizons. Unigrip™ is a trademark of Nobel Biocare AB. Zimmer® Dental ScrewVent® and Tapered ScrewVent® are registered trademarks of Zimmer, Inc. AlloDerm™ and AlloDerm GBR™ are trademarks of LifeCell Corporation, an Allergan affiliate. Grafton® DBM is a registered trademark of Medtronic, Inc. Cytoplast® is a registered trademark of Osteogenics Biomedical, Inc. Puros Dermis is a registered trademark of Zimmer Biomet. Mucograft is a registered trademark of Ed. Geistlich Sogne Ag Fur Chemische Industrie. Symbios PerioDerm is a registered trademark of Dentsply Sirona. Hu-Friedy® is a registered trademark of Hu-Friedy Mfg. Co., LLC. Spiralock® is a registered trademark of Spiralock Corporation. Pomalux® is a registered trademark of Westlake Plastics Co. Locator® is a registered trademark of Zest Anchors, Inc. Delrin® is a registered trademark of E.I. du Pont de Nemours and Company. Bio-Gide® is a registered trademark of Edward Geistlich Sohne AG Fur Chemische Industrie. BioMend® is a registered trademark of Zimmer Biomet Dental. IntraSpin®, L-PRF® and Xpression® are trademarks of Intra-Lock® International Inc. Not all products shown or described in this literature are available in all countries. As applicable, BioHorizons products are cleared for sale in the European Union under the EU Medical Device Directive 93/42/EEC and the tissues and cells Directive 2004/23/EC. We are proud to be registered to ISO 13485:2016, the international quality management system standard for medical devices, which supports and maintains our product licences with Health Canada and in other markets around the globe. Original language is English. ©BioHorizons. All Rights Reserved.



L01021



REV G OCT 2019

shop online at
store.biohorizons.com